

Tapered Roller
Bearing
Double Row
Tapered Roller
Bearing-1097760

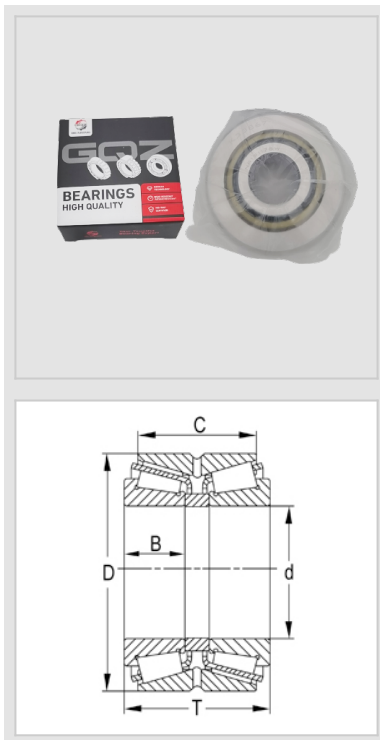

WUXI GUANGQIANG BEARING TRADE CO.,LTD



Bearing No.	1097760
Boundary dimensions [mm]	
d	300
D	500
T	205
C	152
B	90
Basic load ratings (kN)	
Dynamic (Cr)	2090
Static (Cor)	4450
Limiting speed (rpm)	
Grease	530
Oil	710
Mass	
Kg	141

GQZ bearings wholesale high quality Double Row Tapered Roller Bearings

Double row tapered roller bearings are a special type of rolling bearing with two rows of tapered rollers which are arranged along the circumference. The design of this type of bearing allows it to withstand large radial loads as well as axial loads in both directions with high rigidity.

Double row tapered roller bearings are typically used in applications that require heavy loads and bi-directional axial loads, such as machine tools, speed reducers, automobiles, agricultural gearboxes, lifting equipment, rolling mills and mining machinery.

Their design includes an outer ring, two inner rings, spacer rings and rolling elements. By adjusting the thickness of the spacer rings, the clearance and pre-surge of the bearings can be varied to suit different operating conditions and requirements. Double row tapered roller bearings are able to limit the axial displacement of the shaft and housing in both directions, and are indispensable components in many heavy machinery and equipment.



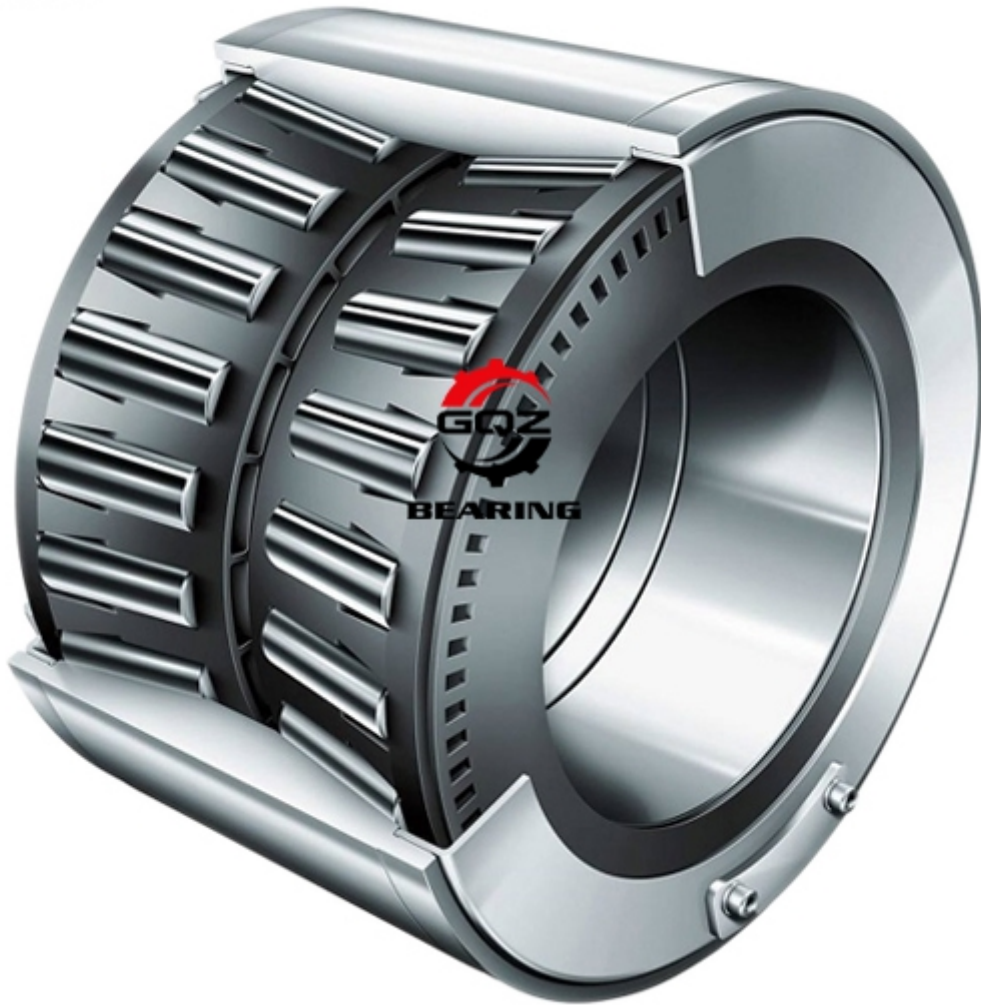



Wuxi Guangqiang Bearing Trade Co.,Ltd-Tel:86-510-82601571-
Email:gq@gqbearing.com,shary@gqbearing.com-http://www.bearing-asia.com