

Spherical Roller  
Bearing  
21300 Series  
spherical roller  
bearings-21308K

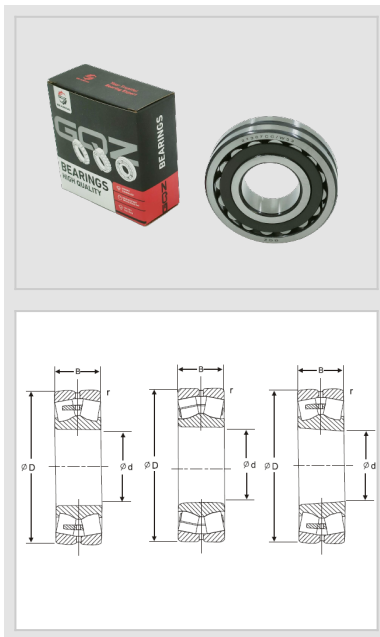

WUXI GUANGQIANG BEARING TRADE CO.,LTD



Designation	<b>21308K</b>
Principal Dimensions(mm)	
d	40
D	90
B	23
rs min	1.5
Basic Load Ratings(KN)	
Dynamic(Cr)	88
Static(Cor)	90
Limited Speed(rpm)	
Grease	3200
Oil	4900
Weight	
(kg)	0.694

## GQZ bearings wholesale high quality 21300 series spherical roller bearings

**The dimensional parameters of 21300 series spherical roller bearings include inner diameter, outer diameter and thickness.**

For 21307E.TVPB bearings, the dimensions are 35mm inner diameter, 80mm outer diameter and 21mm thickness.

For 21308EAKE4 bearings, the dimensions are 40mm inner diameter, 90mm outer diameter and 23mm thickness.

For 21314CA bearings, the dimensions are 70mm inner diameter, 150mm outer diameter and 35mm thickness.

The features of the 21300 series spherical roller bearings include self-aligning properties, the ability to withstand large radial loads, a small amount of axial loads in both directions, and high temperature usage characteristics.

The 21300 series spherical roller bearings are self-aligning, which means that the outer ring of the bearing is spherical with the bearing center point as the bead center, is self-aligning, and there is linear contact between the rolling elements and the raceways of the inner and outer rings, which can withstand large radial loads. These bearings are suitable for applications with large radial loads and can also withstand small amounts of axial loads in both directions. In addition, the 21300 series spherical roller bearings also have high-temperature use characteristics, suitable for working conditions that need to withstand high-temperature environments.

The 21300 series spherical roller bearings have a particularly wide range of applications and are mainly

## 21300-Series-spherical-roller-bearings-21308K

used in safety instruments, energy storage machines, rehabilitation and training equipment, beans, dairy processing equipment, vehicle detectors, mist and oil removal, impact drills, electrical instruments, gear pumps, automotive lamps and other equipment. In addition, 21307E.TVPB bearings, as a member of the 21300 series, are also widely used in a variety of applications, including but not limited to AC welders, mesh belt ovens, cleaning machinery, flash dryers, binding machines, manual welders, rotary dryers, mixing equipment for laboratory use, plastics and rubber industries, ironing tables and so on.





Wuxi Guangqiang Bearing Trade Co.,Ltd-Tel:86-510-82601571-  
Email:qq@gqbearing.com,shary@gqbearing.com-http://www.bearing-asia.com