

Spherical Roller
Bearing
22200 Series
Spherical roller
bearings-22215K

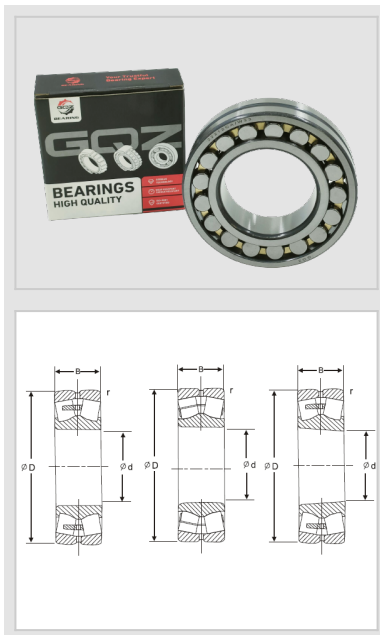

WUXI GUANGQIANG BEARING TRADE CO.,LTD



Designation	22215K
Principal Dimensions(mm)	
d	75
D	130
B	31
rs min	1.5
Basic Load Ratings(KN)	
Dynamic(Cr)	166
Static(Cor)	223
Limited Speed(rpm)	
Grease	2300
Oil	3600
Weight	
(kg)	1.61

GQZ bearings wholesale high quality 22200 series spherical roller bearings

The characteristics of 22200 series spherical roller bearings include high radial load capacity, good alignment performance, and the ability to withstand certain axial loads.

22200 series spherical roller bearings belong to the series of spherical roller bearings, its design features are mainly reflected in the following aspects:

1□High radial load capacity: 22200 series spherical roller bearings have high radial load capacity, especially suitable for heavy load or vibration load work. The design of this bearing makes it able to maintain stable operation under heavy pressure or vibration.

2□Good self-aligning performance: Due to the outer ring raceway design of spherical shape, this bearing has good self-aligning performance and can compensate for coaxiality error. Even in the case of shaft bending or mounting of different centers, the bearing can still be used normally, which is especially suitable for the mounting error or shaft deflection caused by angular error occasions.

3□Able to withstand a certain amount of axial load: In addition to mainly withstand radial load, 22200 series spherical roller bearings can also withstand a certain amount of axial load, which makes it in a number of directions in the load bearing ability is stronger, improve the stability and reliability of the equipment.

4□Adapt to different installation needs: the inner bore of this type of bearing has two kinds: cylindrical and conical, and the bearings with conical bore can be conveniently and quickly assembled on the shafts of optical shafts or stepped machine shafts by equipping them with tightening sleeves or retreating sleeves, so as to adapt to different installation needs.

22200-Series-Spherical-roller-bearings-22215K

22200 spherical roller bearings are widely used in many fields, including paper making machinery, deceleration devices, railroad vehicle axles, rolling mill gearbox bearing housings, rolling mill rollers, crushers, vibrating screens, printing machinery, woodworking machinery, and various types of industrial speed reducers. In addition, it also plays an important role in automobile gearboxes and heavy-duty low-speed rotary applications. These bearings are self-aligning and can withstand misalignment and shaft deflection with little or no increase in friction or temperature, making them suitable for high-temperature operating machinery, such as steel mill metallurgy, boiler fans, kiln carriages, liquid nitrogen equipment, spraying lines, conveyors, vacuum coating machines, and so on.





Wuxi Guangqiang Bearing Trade Co.,Ltd-Tel:86-510-82601571-
Email:qq@gqbearing.com,shary@gqbearing.com-http://www.bearing-asia.com