

Spherical Roller
Bearing
23000 Series
Spherical roller
bearings-23028K

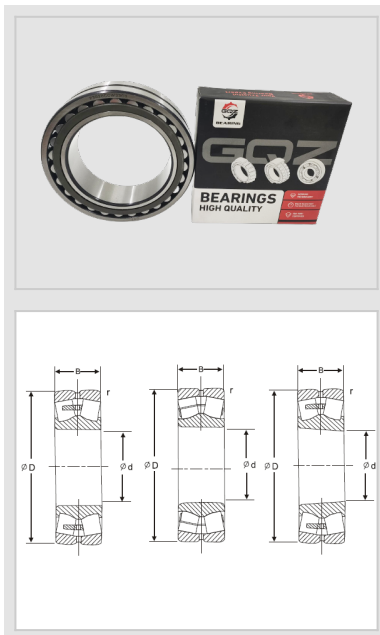

WUXI GUANGQIANG BEARING TRADE CO.,LTD



Designation	23028K
Principal Dimensions(mm)	
d	140
D	210
B	53
rs min	2
Basic Load Ratings(KN)	
Dynamic(Cr)	405
Static(Cor)	690
Limited Speed(rpm)	
Grease	1400
Oil	2200
Weight	
(kg)	6.12

GQZ bearings wholesale high quality 23000 series spherical roller bearings

The main features of 23000 series spherical roller bearings include self-aligning function, high load carrying capacity, high adaptability, and good running performance.

1□Self-aligning function: 23000 series spherical roller bearings have double rows of rollers, the outer ring has a common spherical raceway, the inner ring has two raceways and tilted at an angle relative to the bearing axis. This design makes the bearings have self-aligning performance, which can automatically adjust the axial misalignment caused by the deflection or non-centering of the shaft or shell, thus adapting to the mounting error or angular error caused by the shaft deflection.

2□High load carrying capacity: this kind of bearing is especially suitable for bearing heavy loads and shock loads, and has high radial load capacity. It can not only withstand radial load, but also can withstand a certain amount of axial load, has a good radial load capacity, widely used in mining machinery, power machinery, textile machinery, heavy machinery and other industries.

3□Strong adaptability: the design of spherical roller bearings allows adjustment of the direction of the two perpendicular axes, so they have good adaptability in installation and operation. Their rollers roll freely on the raceway and distribute the load evenly, which helps to reduce friction and wear, and they are adaptable to various unstable factors such as tilting.

4□Good running performance: Spherical roller bearings run with low noise, providing high efficiency and high speed running performance, suitable for application environments requiring high efficiency and reliability rotary dryers, laboratory mixing equipment, plastic and rubber industries, ironing tables, etc. The bearings are suitable for applications that require high efficiency and reliability.

23000 series spherical roller bearings are widely used in papermaking machinery, deceleration devices,

23000-Series-Spherical-roller-bearings-23028K

railroad vehicle axles, rolling mill gearbox bearing housing, rolling mill rollers, crusher, vibrating screen, printing machinery, woodworking machinery, all kinds of industrial speed reducer and other industry fields.



23000-Series-Spherical-roller-bearings-23028K



Wuxi Guangqiang Bearing Trade Co.,Ltd-Tel:86-510-82601571-
Email:gq@gqbearing.com,shary@gqbearing.com-http://www.bearing-asia.com