

Spherical Roller
Bearing
23100 Series
spherical roller
bearing-23126W33C3

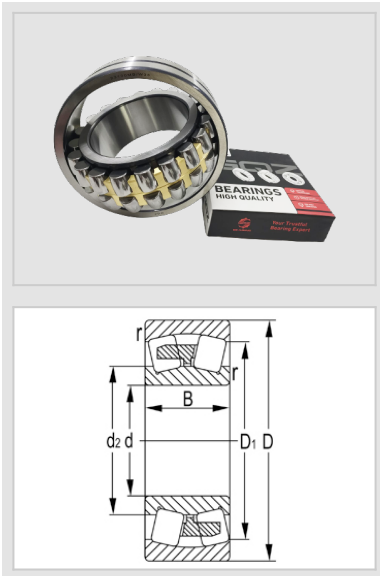

WUXI GUANGQIANG BEARING TRADE CO.,LTD



Designation **23126W33C3**

Principal Dimensions(mm)

d 130

D 210

B 64

rs min **2**

Basic Load Ratings(KN)

Dynamic(Cr) 495

Static(Cor) 795

Limited Speed(rpm)

Grease 1300

Oil 2000

Weight

(kg) 8.47

GQZ bearings wholesale high quality 23100 series spherical roller bearings

23100 Spherical Roller Bearing is a kind of spherical roller bearing with specific size and performance, its features mainly include:

1 Double-row roller design: Spherical roller bearings have double rows of rollers, and this structure gives the bearings the function of self-aligning, which makes them suitable for heavy loads and shock loads in the working environment.

2 HIGH RIGIDITY AND SPEED: 23100 spherical roller bearings have high rigidity and speed, as well as low noise, and can adapt to various unstable factors, such as tilting.

3 Strong adaptability: the design of the bearing allows adjustment of the direction of the two perpendicular axes, with good adaptability to withstand combined radial and axial loads, but the radial load is the main source of load carrying capacity.

4 Internal structure: Its internal structure helps the rollers roll freely on the raceway and evenly distributes the load, which helps to reduce friction and wear and improve the service life and reliability of the bearings.

23100 spherical roller bearings are widely used in paper making machinery, speed reducing devices, railroad vehicle axles, rolling mill gearbox bearing housings, rolling mill rollers, crushers, vibrating screens, printing machinery, woodworking machinery, all kinds of industrial speed reducers and other fields.





Wuxi Guangqiang Bearing Trade Co.,Ltd-Tel:86-510-82601571-
Email:gg@gqbearing.com,shary@gqbearing.com-http://www.bearing-asia.com