

Spherical Roller
Bearing
23200 Series spherical
roller
bearings-23226W33C3

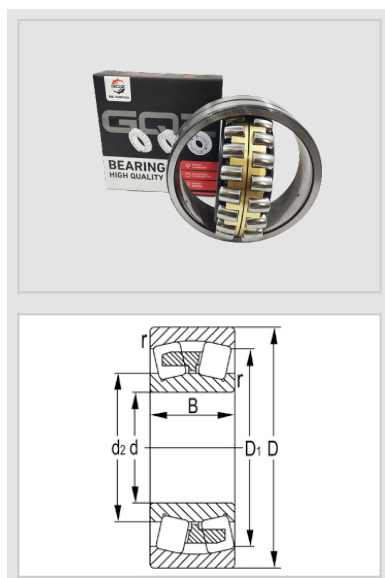

WUXI GUANGQIANG BEARING TRADE CO.,LTD



Designation **23226W33C3**

Principal Dimensions(mm)

d 130

D 230

B 80

rs min **3**

Basic Load Ratings(KN)

Dynamic(Cr) 685

Static(Cor) 1060

Limited Speed(rpm)

Grease 1200

Oil 1900

Weight

(kg) 14.3

GQZ bearings wholesale high quality 23200 series spherical roller bearings

The characteristics of 23200 series spherical roller bearings mainly include high radial load capacity, good self-aligning performance, and suitability for operating environments subject to heavy loads or vibration loads.

1□ high radial load capacity: 23200 series spherical roller bearings have a large radial load capacity, this is because of its structural features include spherical raceway outer ring and double raceway inner ring is equipped with spherical roller. This structure enables the bearings to withstand large radial loads, especially suitable for heavy loads and shock loads in the working environment.

2□good self-aligning performance: due to the outer ring raceway arc center and bearing center, this design has self-aligning performance, can automatically adjust due to the shaft or shell of the deflection or not centered caused by the axial misalignment. This kind of centering performance makes the bearings can compensate for the coaxiality error within a certain range, and ensure that the bearings can still work normally under the situation of angular error caused by mounting error or shaft deflection.

23200 series spherical roller bearings are mainly used in papermaking machinery, deceleration devices, railroad vehicle axles, rolling mill gearbox housings, rolling mill rollers, crushers, vibrating screens, printing machinery, woodworking machinery, all kinds of industrial speed reducer and other industry fields. In addition, it is also suitable for forging machine tools, casting machine tools, molding machine tools, metal cutting machine tools, tool fixtures, machine tool accessories and other fields. These bearings have two rows of symmetrically arranged spherical rollers, rollers in the outer ring in the spherical raceway can be freely adjusted, the shaft deformation and bearing seat misalignment error compensation, has a high radial load capacity, especially suitable for heavy loads or vibration loads under the work, but can not withstand pure axial load.





Wuxi Guangqiang Bearing Trade Co.,Ltd-Tel:86-510-82601571-
Email:gg@gqbearing.com,shary@gqbearing.com-http://www.bearing-asia.com