

Spherical Roller
Bearing
24100 Series spherical
roller
bearings-24134W33C3

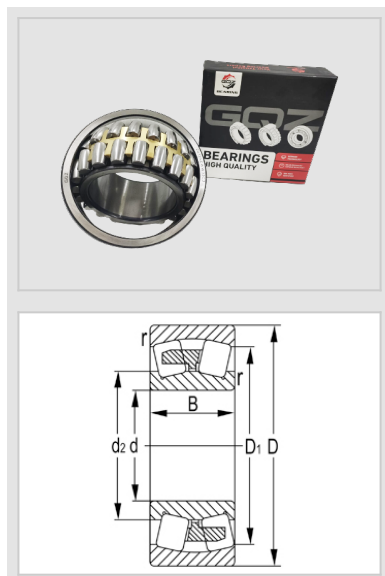

WUXI GUANGQIANG BEARING TRADE CO.,LTD



Designation **24134W33C3**

Principal Dimensions(mm)

d 170

D 280

B 109

rs min 2.1

Basic Load Ratings(KN)

Dynamic(Cr) 1080

Static(Cor) 1880

Limited Speed(rpm)

Grease 960

Oil 1500

Weight

(kg) 27.2

GQZ bearings wholesale high quality 24100 series spherical roller bearings

24100 series spherical roller bearings are a series of spherical roller bearings with specific models, whose characteristics mainly include:

1 Withstand load capacity: Spherical roller bearings are mainly used to withstand radial load, but also can withstand a certain amount of axial load, but generally can not withstand pure axial load. The outer ring raceway of this type of bearing is spherical, with self-aligning performance, when the shaft is bent or tilted, the bearing can still work normally.

2 Structural characteristics: the structural principle of self-aligning roller bearings and self-aligning ball bearings are the same, the only difference is that the rolling body is spherical roller. Due to the different rolling bodies, the bearing capacity of spherical roller bearings is larger, and they are widely used in mining and heavy machinery. This type of bearing can limit the axial displacement of the shaft or shell within the axial clearance of the bearing.

3 Application areas: Spherical roller bearings and spherical ball bearings can be used in place of each other in accordance with the capacity and limit rotational speed permits, and are widely used in metallurgy, automotive instrumentation, cutting machine, hydraulic cylinder buffer, dynamic wheel lathe, sterilizer class, kitchen knife, clothing accessories, lifting skids, automotive lamps and other equipment.

4 Model diversity: 24100 series spherical roller bearings include a number of models, such as 24120, 24122, 24124, 24126, 24128, 24130, 24132, 24134, 24136, 24138, 24140, 24144, 24148, 24144, 24148, 24152, 24156, etc. Each model has its specific use and performance parameters.

24100 series spherical roller bearings are mainly used in high load mining machinery, steel mills, oil fields and other fields.





Wuxi Guangqiang Bearing Trade Co.,Ltd-Tel:86-510-82601571-
Email:gq@gqbearing.com,shary@gqbearing.com-http://www.bearing-asia.com