

Single Row
Tapered Roller
Bearing
30200 Tapered
Roller
Bearing-30222J2

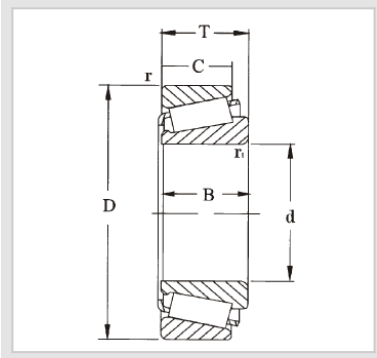

WUXI GUANGQIANG BEARING TRADE CO.,LTD



Designation	30222J2
Principal dimensions [mm]	
d1	110
D	200
B	41
Basic load ratings [kN]	
dyc(Cr)	308
stc(Cor)	405
Pu	45
Speed ratings [rpm]	
Speed Ratings	2400
Limiting Speed	3200
Weight(Kg)	5.10
ISO335	
Dimensions (ABMA)	3FB
Dimensions [mm]	
d	110
d1	148
B	38
C	32
r1,2(min)	3
r3,4(min)	2.5
a	39
Abutment and fillet dimensions [mm]	
da(max)	129
db(min)	122
Da(min)	174
Da(max)	188
Db(min)	187
Ca(min)	6
Cb(min)	9
ra(max)	2.5
rb(max)	2
Value	
e	0.43
Y	1.4
Yo	0.8

GQZ high quality 30200 Single Row Tapered Roller Bearing

The dimensions of 30200 tapered roller bearing include an inner diameter of 10mm, an outer diameter of 30mm and a height of 10.25mm.

The 30200 series tapered roller bearing are a commonly used mechanical part and are widely used in a variety of mechanical equipment. Their design features include separable parts, no seals, high speed usage characteristics, and the use of high carbon chrome bearing steel (GCr15) as the material. The rolling bodies of these bearings are tapered rollers with a convex raceway design and no sealing cap, making them suitable for general-purpose use, especially in applications requiring high-speed operation. In addition, the cages of 30200 series tapered roller bearings are made of stamped J steel plate and weigh about 0.036kg.

30200 tapered roller bearing are mainly subjected to radial mainly diameter, axial joint load, its load carrying capacity depends on the raceway angle of the outer ring, the larger the angle the greater the load carrying capacity. This kind of bearing belongs to the separated type, which means that the inner ring assembly (with roller and cage) can be mounted separately from the outer ring. According to the number of columns of rolling bodies in the bearing, it is divided into single row, double row and four rows of tapered roller bearings. For single row tapered roller bearings, the clearance needs to be adjusted by the user during installation, while for double row and four row tapered roller bearings, the clearance has been set according to the user's requirements at the time of shipment, and does not need to be adjusted by the user. Tapered roller bearings have conical inner ring and outer ring raceway, tapered rollers are arranged between the two, all the tapered surface of the projection line in the bearing axis of the same point of convergence. This design makes tapered roller bearings particularly suitable for bearing composite (radial and axial) loads, in which the axial load capacity is mostly determined by the contact angle α , the larger the α angle, the higher the axial load capacity. Therefore, tapered roller bearings play an important role in many applications due to their special design and excellent load carrying capacity.



30200-Tapered-Roller-Bearing-30222J2



Wuxi Guangqiang Bearing Trade Co.,Ltd-Tel:86-510-82601571-
Email:qq@gqbearing.com,shary@gqbearing.com-http://www.bearing-asia.com