

Single Row
Tapered Roller
Bearing
31300 Tapered
Roller
Bearing-31317J2

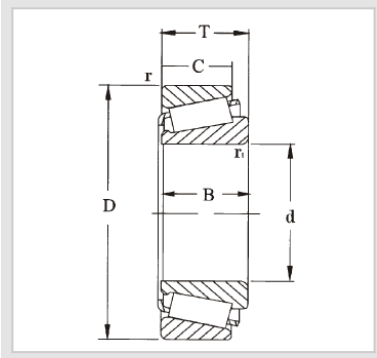

WUXI GUANGQIANG BEARING TRADE CO.,LTD



Designation	31317J2
Principal dimensions [mm]	
d1	85
D	180
B	44.5
Basic load ratings [kN]	
dyc(Cr)	242
stc(Cor)	285
Pu	33.5
Speed ratings [rpm]	
Speed Ratings	2600
Limiting Speed	3800
Weight(Kg)	4.60
ISO335	
Dimensions (ABMA)	7GB
Dimensions [mm]	
d	85
d1	131
B	41
C	28
r1,2(min)	4
r3,4(min)	3
a	55
Abutment and fillet dimensions [mm]	
da(max)	103
db(min)	99
Da(min)	143
Da(max)	166
Db(min)	169
Ca(min)	6
Cb(min)	16.5
ra(max)	3
rb(max)	2.5
Value	
e	0.83
Y	0.72
Yo	0.4

GQZ bearings wholesale high quality 31300 Single Row Tapered Roller Bearing

31303 tapered roller bearings, the inner diameter is 17mm, the outer diameter is 47mm and the width is 15.5mm.

31330 tapered roller bearings, the inner diameter is 150mm, an outer diameter is 320mm and a width is 75mm.

32300 series tapered roller bearings features:

31300 series tapered roller bearings are characterized by strong load carrying capacity, smooth operation and long service life, which are widely used in automobile, engineering machinery, metallurgical equipment, mining machinery and other fields.

31300 series tapered roller bearings belong to a kind of roller bearings, its inner and outer ring raceway cross-section is conical, mainly to bear radial load mainly radial and axial combined load, at the same time, can also withstand tilting moment. The design of this type of bearing enables it to provide stable support and load carrying capacity in various applications, thus ensuring stable operation and long-term use of the equipment.







Wuxi Guangqiang Bearing Trade Co.,Ltd-Tel:86-510-82601571-
Email:qq@gqbearing.com,shary@gqbearing.com-http://www.bearing-asia.com