

Tapered Roller  
Bearing  
Double Row  
Tapered Roller  
Bearing-3519/600

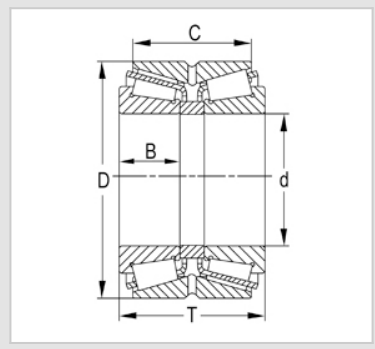

WUXI GUANGQIANG BEARING TRADE CO.,LTD



Bearing No.	<b>3519/600</b>
Boundary dimensions [mm]	
d	<b>600</b>
D	800
T	205
C	156
B	90
Basic load ratings (kN)	
Dynamic (Cr)	3100
Static (Cor)	9050
Limiting speed (rpm)	
Grease	290
Oil	390
Mass	
Kg	247

## GQZ bearings wholesale high quality Double Row Tapered Roller Bearings

**Double row tapered roller bearings** are a special type of rolling bearing with two rows of tapered rollers which are arranged along the circumference. The design of this type of bearing allows it to withstand large radial loads as well as axial loads in both directions with high rigidity.

**Double row tapered roller bearings** are typically used in applications that require heavy loads and bi-directional axial loads, such as machine tools, speed reducers, automobiles, agricultural gearboxes, lifting equipment, rolling mills and mining machinery.

Their design includes an outer ring, two inner rings, spacer rings and rolling elements. By adjusting the thickness of the spacer rings, the clearance and pre-surge of the bearings can be varied to suit different operating conditions and requirements. Double row tapered roller bearings are able to limit the axial displacement of the shaft and housing in both directions, and are indispensable components in many heavy machinery and equipment.

Double-Row-Tapered-Roller-Bearing-3519600



Double-Row-Tapered-Roller-Bearing-3519600

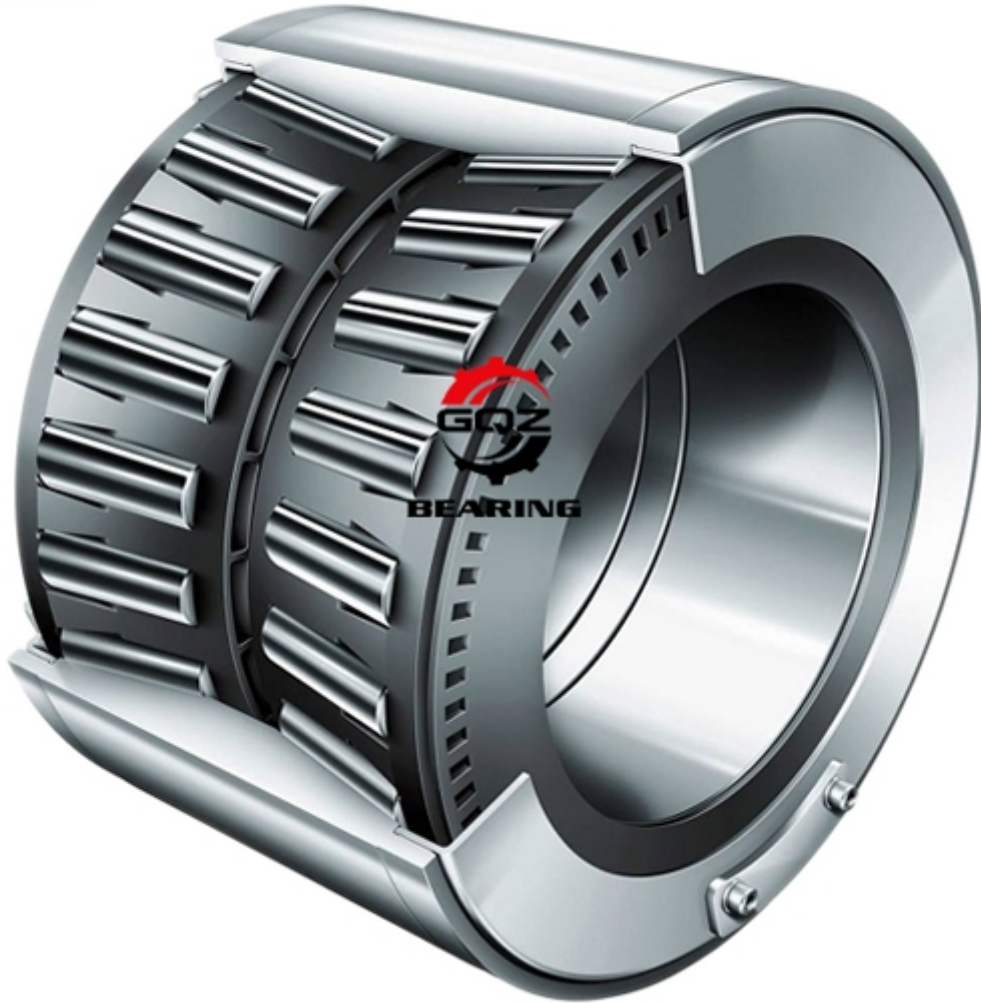

Double-Row-Tapered-Roller-Bearing-3519600



Wuxi Guangqiang Bearing Trade Co.,Ltd-Tel:86-510-82601571-  
Email:gq@gqbearing.com,shary@gqbearing.com-http://www.bearing-asia.com