

Double Row  
Angular Contact  
Ball Bearings  
3000A-2RS Series  
angular contact ball  
bearings-3805A-2RS

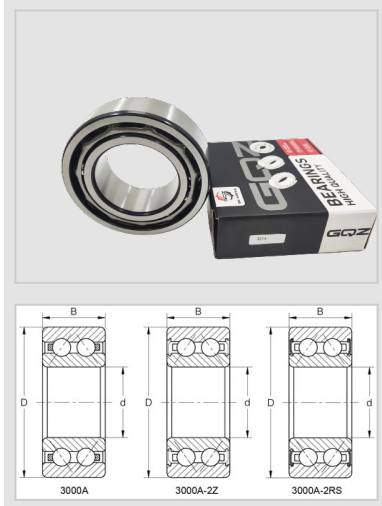

WUXI GUANGQIANG BEARING TRADE CO.,LTD



Designation **3805A-2RS**

Principal Dimensions(mm)

d 25

D 37

B 10

Basic Load Ratings(KN)

Dynamic(Cr) 5.5

Static(Cor) 4.9

Limited Speed(rpm)

Grease 11500

Oil -

Weight

(kg) 0.025

## GQZ bearings wholesale high quality 3000A-2RS Series Double Row Angular Contact Ball Bearings

The dimensional parameters of 3000A-2RS series bearings include inner diameter of 10mm, outer diameter of 26mm and thickness of 12mm.

3000A-2RS series bearings mainly contain 3000A-2RS and 3001-2RS models.

The 3000A-2RS series bearings are double-row angular contact ball bearings, which are characterized by high speed and low noise. These bearings are typically used in application scenarios where bi-directional axial loads and high rotational speeds are required. Specifically, the models 3000A-2RS and 3001-2RS belong to the category of angular contact ball bearings. The design features of these bearings enable them to maintain good performance at high speeds while providing low noise levels, making them suitable for application environments with high demands on bearing performance.

In addition, the suffix "-2RS" on 3000A-2RS series bearings usually indicates that the bearing is equipped with dust caps on both sides, which is a common sealing method used to protect the bearing from dust and contaminants, thus extending the life of the bearing and maintaining its performance. This design is particularly suited to applications that require frequent lubricant changes or harsh operating environments.





Wuxi Guangqiang Bearing Trade Co.,Ltd-Tel:86-510-82601571-  
Email:gq@gqbearing.com,shary@gqbearing.com-http://www.bearing-asia.com