

NF Series  
N300 Series  
cylindrical roller  
bearing-N319

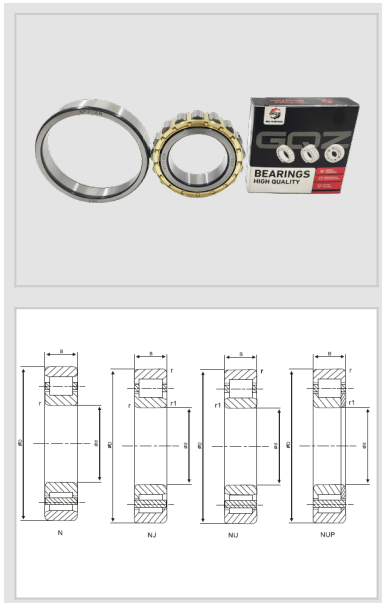

WUXI GUANGQIANG BEARING TRADE CO.,LTD



Designation	<b>N319</b>
Principal Dimensions(mm)	
d	95
D	200
B	45
rs min	<b>3</b>
rs1 min	<b>3</b>
Basic Load Ratings(KN)	
Dynamic(Cr)	259
Static(Cor)	285
Limited Speed(rpm)	
Grease	3400
Oil	4000
Weight	
(kg)	5.99

## GQZ bearings wholesale high quality N300 Series Cylindrical Roller Bearing

The main features of N300 series cylindrical roller bearings are high load carrying capacity, low coefficient of friction, high rotational accuracy, good durability, good adaptability and low maintenance cost.

**N300 series cylindrical roller bearings are a common type of rolling bearings, which are widely used in various mechanical equipment. Its main features include:**

- 1 High load carrying capacity:** Cylindrical roller bearings with roller structure can withstand high radial and axial loads, which is suitable for high load rotating bodies.
- 2 Lower coefficient of friction:** Due to the larger rolling contact area of cylindrical roller bearings, the coefficient of friction is lower, so they have better lubrication performance and lower friction resistance, which can effectively reduce mechanical energy consumption and wear.
- 3 Higher rotational accuracy:** the use of precision machining technology, high rotational accuracy, can ensure the stability and accuracy of mechanical equipment.
- 4 Good durability:** adopting high quality materials and advanced heat treatment technology, it has good durability and long service life.
- 5 Better adaptability:** different designs, materials and sizes can be selected according to different application requirements, with strong adaptability and flexibility.
- 6 Lower maintenance cost:** with lower maintenance cost, only need regular lubrication and inspection to ensure its normal operation.

## N300-Series-cylindrical-roller-bearing-N319

These features make the cylindrical roller bearings become a load-bearing and smooth movement of the weapon, widely used in the front gang machine, flange, test sieve, suction on the gun, inverter welder and many other equipment and machinery.





Wuxi Guangqiang Bearing Trade Co.,Ltd-Tel:86-510-82601571-  
Email:qq@gqbearing.com,shary@gqbearing.com-http://www.bearing-asia.com