

NF Series
NF200 Series
cylindrical roller
bearing-NF219E

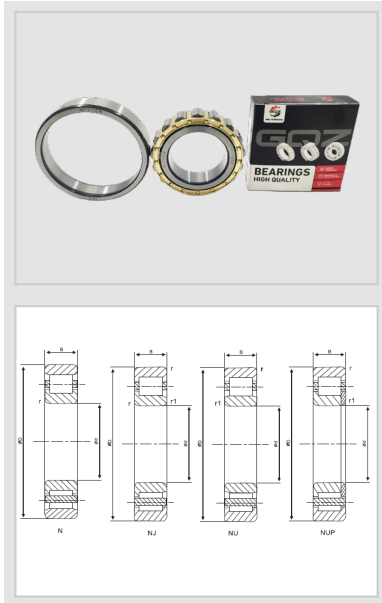

WUXI GUANGQIANG BEARING TRADE CO.,LTD



Designation	NF219E
Principal Dimensions(mm)	
d	95
D	170
B	32
rs min	2.1
rs1 min	2.1
Basic Load Ratings(KN)	
Dynamic(Cr)	192
Static(Cor)	214
Limited Speed(rpm)	
Grease	3200
Oil	4000
Weight	
(kg)	2.8

GQZ bearings wholesale high quality NF200 Series Cylindrical Roller Bearing

The dimensional parameters of NF200 series bearings are inner diameter $d=110$ mm, outer diameter $OD=200$ mm, thickness $B=38$ mm.

The characteristics of NF200 series bearings are mainly.

- 1.NF200 series bearings are designed to emphasize high performance and durability to meet the needs of various industrial applications. These bearings typically have high load carrying capacity and good operational stability, and can maintain stable performance at high speeds and under heavy load conditions. In addition, NF200 series bearings have good wear and fatigue resistance, which extends service life and reduces maintenance requirements.
- 2.NF200 series bearings are widely used in forging machine tools, casting machine tools, molding machine tools, metal cutting machine tools, cutting tools and fixtures, and machine tool accessories. These applications have high demands on bearing performance and durability, which the NF200 series bearings are able to meet due to their excellent design and performance, ensuring stable operation and efficient production.
3. NF200 series bearings have high radial and axial load capacity, which is suitable for bearing heavy loads and shock loads. In addition, these bearings have a good self-aligning function, which can automatically adjust the shaft and shell when there is deflection to maintain stable operation of the equipment. These performance advantages make NF200 series bearings an ideal choice for various industrial applications.





Wuxi Guangqiang Bearing Trade Co.,Ltd-Tel:86-510-82601571-
Email:gq@gqbearing.com,shary@gqbearing.com-http://www.bearing-asia.com