

NF Series
NF2200 Series
cylindrical roller
bearing-NF2205EM

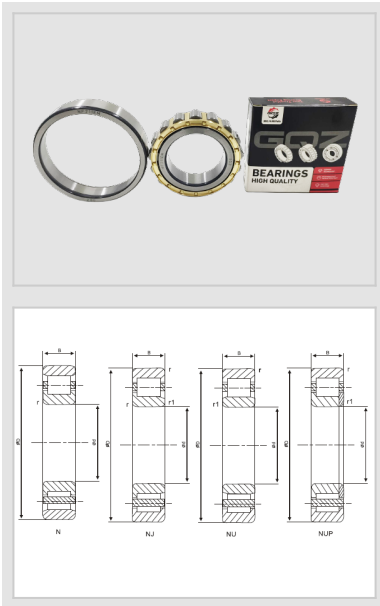

WUXI GUANGQIANG BEARING TRADE CO.,LTD



Designation **NF2205EM**

Principal Dimensions(mm)

d	25
D	52
B	18
rs min	1
rs1 min	0.6

Basic Load Ratings(KN)

Dynamic(Cr)	23.7
Static(Cor)	22.8

Limited Speed(rpm)

Grease	10000
Oil	14000

Weight

(kg)	0.168
------	-------

GQZ bearings wholesale high quality NF2200 Series Cylindrical Roller Bearing

The characteristics of NF2200 series tapered roller bearings mainly include high load carrying capacity, self-aligning performance, high temperature resistance, adaptability, high reliability and easy maintenance.

High load carrying capacity: Tapered roller bearings have a large load carrying capacity and can operate stably under heavy loads and shock loads. This makes them ideal for bearing heavy loads, such as rolling mills, cranes, mining equipment, and so on.

Spherical performance: Tapered roller bearings have good spherical performance, which can automatically adjust the shaft center deviation, so that the shaft bearing force is uniform. This helps to reduce bearing wear and fatigue, and extends the service life of the bearings.

High-temperature resistance performance: the use of high-temperature-resistant materials and grease enables them to operate stably in high-temperature environments. This makes them ideal for use in high-temperature industrial applications, such as hot rolling mills, hot forging machines, and heat treatment equipment.

Adaptability: They are suitable for various types of mechanical transmission systems, such as rotary, sliding and rolling. They are also suitable for a wide range of different installation methods, such as face-to-face, back-to-back, tandem, etc. They have a wide range of applicability.

High reliability: Adopting precision processing and strict quality control, they have good stability and reliability. Under proper use and maintenance, it can operate stably for a long time, reducing failure and maintenance costs.

NF2200-Series-cylindrical-roller-bearing-NF2205EM

Easy maintenance: the design makes maintenance and replacement easy and convenient. Most tapered roller bearings can be mounted and dismounted through the sides or ends without taking the entire drive train apart. In addition, proper lubrication and maintenance can extend bearing life.

These features make NF2200 series tapered roller bearings perform well in a variety of industrial applications, providing reliable support whether they are subjected to heavy loads, adapted to high-temperature environments or ensuring the stable operation of mechanical equipment.





Wuxi Guangqiang Bearing Trade Co.,Ltd-Tel:86-510-82601571-
Email:gg@gqbearing.com,shary@gqbearing.com-http://www.bearing-asia.com