

NF Series  
NF300 Series  
cylindrical roller  
bearing-NF316E

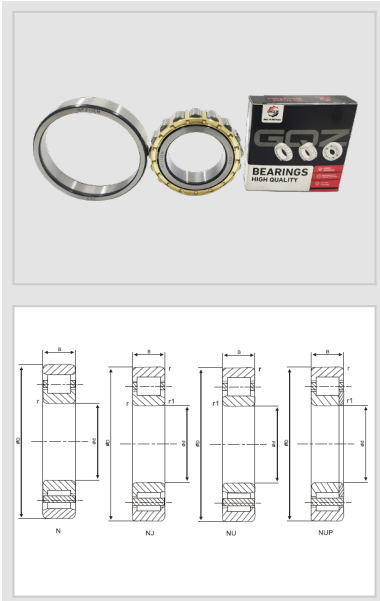

WUXI GUANGQIANG BEARING TRADE CO.,LTD



Designation	<b>NF316E</b>
Principal Dimensions(mm)	
d	80
D	170
B	39
rs min	2.1
rs1 min	2.1
Basic Load Ratings(KN)	
Dynamic(Cr)	245
Static(Cor)	270
Limited Speed(rpm)	
Grease	3400
Oil	4300
Weight	
(kg)	3.9

## GQZ bearings wholesale high quality NF300 Series Cylindrical Roller Bearing

The main dimensions of NF300 cylindrical roller bearings include inner diameters from 10mm to 25mm, outer diameters of 35mm, and widths of 11.0mm.

The characteristics of NF300 series cylindrical roller bearings mainly include high radial load carrying capacity, low coefficient of friction, allowing small tilt between the inner ring axis and the outer ring axis, as well as being suitable for bearing heavy loads and shock loads.

**The design of NF300 series cylindrical roller bearings gives them the following characteristics:**

**1 High Radial Load Carrying Capacity:** This bearing type is capable of carrying large radial loads due to its line contact or trimmed down line contact design of the rollers and raceways.

**2 Low coefficient of friction:** the bearings have a low coefficient of friction and are suitable for high speeds, with limiting speeds close to those of deep groove ball bearings.

**3 Allow the inner ring axis and the outer ring axis tilt is small:** in order to ensure the load capacity and service life of the bearing, the allowable tilt of the inner ring axis and the outer ring axis is very small, usually between 2 ° - 4 °. More than this tilt, roller and collar raceway contact will deteriorate, seriously affecting the load capacity of the bearing.

**4 Suitable for heavy loads and shock loads:** Due to the above characteristics, NF300 series cylindrical roller bearings are particularly suitable for application scenarios where heavy loads and shock loads are required.

## NF300-Series-cylindrical-roller-bearing-NF316E

In addition, NF300 series cylindrical roller bearings have separable inner or outer rings for easy mounting and dismounting. This bearing type is typically used in applications requiring high radial loads and high rotational speeds, and although it cannot withstand axial loads, it can be used in host components that need to withstand axial loads by using other types of bearings in conjunction.





Wuxi Guangqiang Bearing Trade Co.,Ltd-Tel:86-510-82601571-  
Email:qq@gqbearing.com,shary@gqbearing.com-http://www.bearing-asia.com