

NU Series  
 NU200  
 cylindrical roller  
 bearing-**NU218**

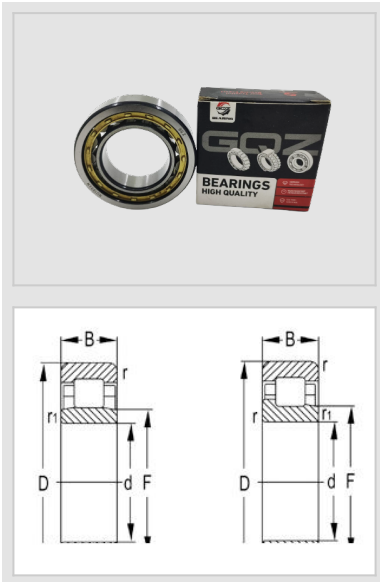

**WUXI GUANGQIANG BEARING TRADE CO.,LTD**



Designation	<b>NU218</b>
Principal Dimensions(mm)	
d	90
D	160
B	30
rs min	<b>2</b>
rs1 min	<b>2</b>
Basic Load Ratings(KN)	
Dynamic(Cr)	152
Static(Cor)	178
Limited Speed(rpm)	
Grease	4300
Oil	5000
Weight	
(kg)	2.3

## GQZ bearings wholesale high quality NU200 Cylindrical Roller Bearing

**NU200 series bearings are a type of cylindrical roller bearings with the following characteristics:**

**Dimensional parameters:** the inner diameter is 200mm, the outer diameter is 360mm, and the thickness is 58mm. these dimensional parameters make the NU200 series bearings suitable for application scenarios that require large radial loads.

**Design features:** Optimization of the design of the rollers and retaining edges improves the axial load carrying capacity of the bearings. At the same time, the geometric surface design between the rollers and raceways is optimized to balance the distribution of radial loads. These design features enable NU200 series bearings to maintain good performance under high loads and high speeds.

**Application Areas:** NU200 bearings are widely used in a variety of mechanical equipment, including but not limited to cross-cutting machines, veterinary instruments, wire drying machines, hydrostatic guides, screening equipment, electrostatic spraying machines, CNC welding machines, textile auxiliary equipment, gear milling machines, air flotation equipment, worm gear reducer, ironing machines, foaming equipment, food packaging machines coolers, tire diggers, magnetic pumps, balancing machines, and more. These applications cover many aspects of industrial production, showing the wide applicability and reliability of NU200 series bearings.

In summary, NU200 series bearings play an important role in the industrial field with their specific dimensional parameters and design features, and can meet the needs of various mechanical equipment for high loads and high speeds.





Wuxi Guangqiang Bearing Trade Co.,Ltd-Tel:86-510-82601571-  
Email:gq@gqbearing.com,shary@gqbearing.com-http://www.bearing-asia.com