

NU Series
 NU2300
 cylindrical roller
 bearing-**NU2330E**

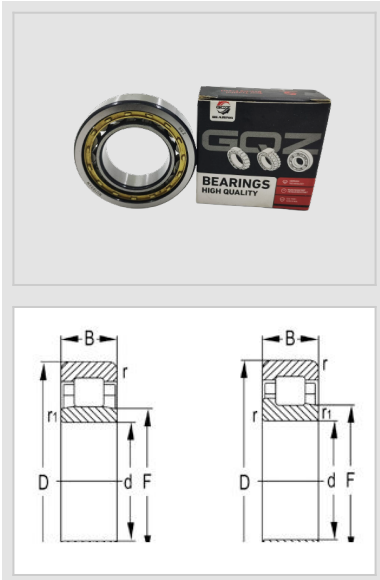

WUXI GUANGQIANG BEARING TRADE CO.,LTD



Designation	NU2330E
Principal Dimensions(mm)	
d	150
D	320
B	108
rs min	4
rs1 min	4
Basic Load Ratings(KN)	
Dynamic(Cr)	1160
Static(Cor)	1600
Limited Speed(rpm)	
Grease	1700
Oil	2000
Weight	
(kg)	47.2

GQZ bearings wholesale high quality NU2300 Cylindrical Roller Bearing

The characteristics of NU2300 cylindrical roller bearings mainly include:

Rollers and raceways are in line contact or under repair line contact, which makes NU2300 series bearings have large radial load carrying capacity, very suitable for bearing heavy loads and shock loads.

The coefficient of friction is small, suitable for high-speed operation, and its limiting speed is close to that of deep groove ball bearings, which makes NU2300 series bearings perform well in occasions requiring high-speed operation.

N type and NU type can be moved axially, can adapt to changes in the relative position of the shaft and the shell caused by thermal expansion or mounting errors, and can be used as a free end support.

Higher processing requirements for the shaft or seat hole, bearing installation of the outer ring axis of the relative skew should be strictly controlled, so as not to cause contact stress concentration.

Inner or outer ring can be separated, easy to install and dismantle.





Wuxi Guangqiang Bearing Trade Co.,Ltd-Tel:86-510-82601571-
Email:qq@gqbearing.com,shary@gqbearing.com-http://www.bearing-asia.com